

## DAU SINGLE SURFACE

### D92126R9-

base number Finish Options

- To build a product code in our configurator select the specify button on the base model # product page
- To build a manual product code on this datasheet choose from the options listed below in blue font and add the suffix to the base model #

#### GENERAL

Series: Dau  
 Subseries: Dau Single  
 Brand: Milan  
 Division: Design  
 Mounting Type: Surface  
 Mounting Location: Ceiling  
 Subcategory: Downlight

#### PHYSICAL

Shape: Cube  
 Length (mm): 80  
 Length (in): 3 1/8  
 Width (mm): 80  
 Width (in): 3 1/8  
 Height (mm): 91  
 Height (in): 3 9/16  
 Light Distribution: Direct  
 Fixture Finish: BAL / MWL / BSL  
 Fixture Material: Extruded Aluminum

#### ELECTRICAL

Lamp Type: LED  
 Input Wattage (W): 10  
 Total Output Wattage (W): 9.3  
 Dimming: Tri-Mode (Non-Dimming and Phase Dimming (120Vac only) and 0-10V Dimming)  
 Driver Included: No  
 Driver Location: Remote  
 Driver Type: Constant Current  
 Input Voltage (V): 120 - 277  
 Constant Current (MA): 350

#### LED

Number of LEDs: 1  
 Color Temperature (°K): 3000  
 Max. Delivered Lumen (lm): 956  
 CRI: >90 CRI  
 Lamp Life (hrs): 50000

#### OPTICAL

#### RATINGS AND CERTIFICATIONS

Certified By: Certified for North American Standards  
 IP rating: IP20

PROJECT
TYPE
SPECIFIER
QUANTITY
DATE



## DAU SINGLE SURFACE

D92126R9-

PROJECT \_\_\_\_\_

TYPE \_\_\_\_\_

SPECIFIER \_\_\_\_\_

QUANTITY \_\_\_\_\_

DATE \_\_\_\_\_



PROJECT	
TYPE	
SPECIFIER	
QUANTITY	
DATE	

## DAU SINGLE ADJUSTABLE SURFACE

### D92188R9-

base number Finish  
Options

- To build a product code in our configurator select the specify button on the base model # product page
- To build a manual product code on this datasheet choose from the options listed below in blue font and add the suffix to the base model #

#### GENERAL

Series: Dau  
Subseries: Dau Single Adjustable  
Brand: Milan  
Division: Design  
Mounting Type: Surface  
Subcategory: Spots

#### PHYSICAL

Shape: Cube  
Length (mm): 80  
Length (in): 3 1/8  
Width (mm): 80  
Width (in): 3 1/8  
Height (mm): 86  
Height (in): 3 3/8  
Max. Overall Height (mm): 164  
Max. Overall Height (in): 6 7/16  
Light Distribution: Adjustable / Direct  
Fixture Finish: BAL / MWL / BSL  
Fixture Material: Extruded Aluminum

#### ELECTRICAL

Lamp Type: LED  
Input Wattage (W): 10  
Total Output Wattage (W): 9.3  
Dimming: Tri-Mode (Non-Dimming and Phase Dimming (120Vac only) and 0-10V Dimming)  
Driver Included: No  
Driver Location: Remote  
Driver Type: Constant Current - 120 / 277Vac  
Driver Class: Class 2  
Input Voltage (V): 120 - 277  
Constant Current (MA): 350

#### LED

Number of LEDs: 1  
Color Temperature (°K): 3000  
Max. Delivered Lumen (lm): 956  
CRI: >90 CRI  
Lamp Life (hrs): 50000

#### OPTICAL

Optic°: 50  
Adjustability: Rotational 300°; Tilt 90°

#### RATINGS AND CERTIFICATIONS

Certified By: Certified for North American Standards  
IP rating: IP20



## DAU SINGLE ADJUSTABLE SURFACE

D92188R9-

PROJECT \_\_\_\_\_

TYPE \_\_\_\_\_

SPECIFIER \_\_\_\_\_

QUANTITY \_\_\_\_\_

DATE \_\_\_\_\_



D

PROJECT	_____
TYPE	_____
SPECIFIER	_____
QUANTITY	_____
DATE	_____

## DAU SINGLE SURFACE

### D93132R9-

base number \_\_\_\_\_  
 Finish Options \_\_\_\_\_

- To build a product code in our configurator select the specify button on the base model # product page
- To build a manual product code on this datasheet choose from the options listed below in blue font and add the suffix to the base model #

#### GENERAL

Series: Dau \_\_\_\_\_  
 Subseries: Dau Single \_\_\_\_\_  
 Brand: Milan \_\_\_\_\_  
 Division: Design \_\_\_\_\_  
 Mounting Type: Surface \_\_\_\_\_  
 Mounting Location: Wall \_\_\_\_\_  
 Subcategory: Downlight \_\_\_\_\_

#### PHYSICAL

Shape: Cube \_\_\_\_\_  
 Length (mm): 50 \_\_\_\_\_  
 Length (in): 2 \_\_\_\_\_  
 Height (mm): 53 \_\_\_\_\_  
 Depth (mm): 60 \_\_\_\_\_  
 Height (in): 2 1/16 \_\_\_\_\_  
 Depth (in): 2 3/8 \_\_\_\_\_  
 Extension (mm): 60 \_\_\_\_\_  
 Extension (in): 2 3/8 \_\_\_\_\_  
 Light Distribution: Direct \_\_\_\_\_  
 Fixture Finish: CHR / MBL / MWL \_\_\_\_\_  
 Fixture Material: Extruded Aluminum \_\_\_\_\_

#### ELECTRICAL

Lamp Type: LED \_\_\_\_\_  
 Input Wattage (W): 5 \_\_\_\_\_  
 Dimming: Electronic Low Voltage Dimming \_\_\_\_\_  
 Input Voltage (V): 120Vac Direct Line \_\_\_\_\_

#### LED

Number of LEDs: 1 \_\_\_\_\_  
 Color Temperature (°K): 3000 \_\_\_\_\_  
 Max. Delivered Lumen (lm): 500 \_\_\_\_\_  
 CRI: >90 CRI \_\_\_\_\_

#### OPTICAL

#### RATINGS AND CERTIFICATIONS

Certified By: Certified for North American Standards \_\_\_\_\_  
 IP rating: IP20 \_\_\_\_\_



10.8cm (4 1/4")



10.8cm (4 1/4")

J-Box cover plate  
Included

5cm (1 15/16")



6cm (2 3/8")

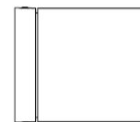

53mm (2 1/16")

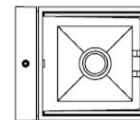

## DAU SINGLE SURFACE

D93132R9-

PROJECT	_____
TYPE	_____
SPECIFIER	_____
QUANTITY	_____
DATE	_____



D

PROJECT
TYPE
SPECIFIER
QUANTITY
DATE

## DAU SINGLE SURFACE

### D93239-

base number            Finish             
Options           

- To build a product code in our configurator select the specify button on the base model # product page
- To build a manual product code on this datasheet choose from the options listed below in blue font and add the suffix to the base model #

#### GENERAL

Series: Dau             
 Subseries: Dau Single             
 Brand: Milan             
 Division: Design             
 Mounting Type: Surface             
 Mounting Location: Wall             
 Subcategory: Downlight           

#### PHYSICAL

Shape: Cube             
 Length (mm): 80             
 Length (in): 3 1/8             
 Height (mm): 80             
 Depth (mm): 101             
 Height (in): 3 1/8             
 Depth (in): 4             
 Extension (mm): 101             
 Extension (in): 4             
 Light Distribution: Direct             
 Fixture Finish: [BAL](#) / [MWL](#) / [BSL](#)             
 Fixture Material: Extruded Aluminum           

#### ELECTRICAL

Lamp Type: LED             
 Input Wattage (W): 7             
 Dimming: Electronic Low Voltage Dimming             
 Input Voltage (V): 120Vac Direct Line           

#### LED

Number of LEDs: 1             
 Color Temperature (°K): 3000             
 Max. Delivered Lumen (lm): 665             
 CRI: >90 CRI             
 Lamp Life (hrs): 50000           

#### OPTICAL

#### RATINGS AND CERTIFICATIONS

Certified By: Certified for North American Standards             
 IP rating: IP20           

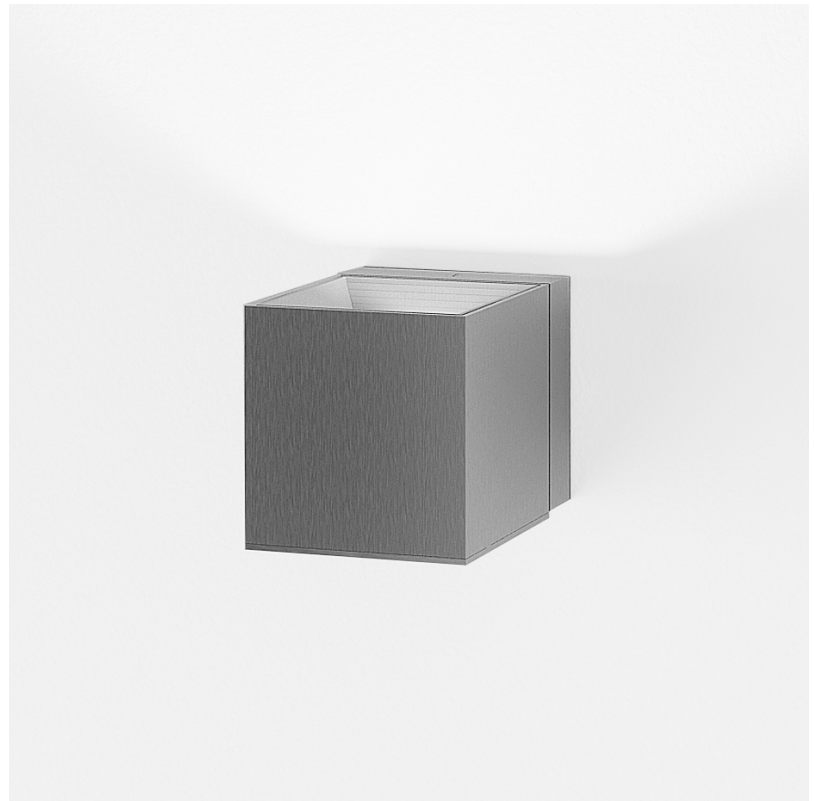

## DAU SINGLE SURFACE

D93239-

PROJECT \_\_\_\_\_

TYPE \_\_\_\_\_

SPECIFIER \_\_\_\_\_

QUANTITY \_\_\_\_\_

DATE \_\_\_\_\_



D



PROJECT	_____
TYPE	_____
SPECIFIER	_____
QUANTITY	_____
DATE	_____

## DAU SINGLE TRACK

### D96048R9-

base number Finish  
Options

- To build a product code in our configurator select the specify button on the base model # product page
- To build a manual product code on this datasheet choose from the options listed below in blue font and add the suffix to the base model #

#### GENERAL

Series: Dau  
 Subseries: Dau Single  
 Brand: Milan  
 Division: Design  
 Mounting Type: Track  
 Mounting Location: Ceiling  
 Subcategory: Spots

#### PHYSICAL

Shape: Cube  
 Width (mm): 80  
 Width (in): 3 1/8  
 Height (mm): 165  
 Height (in): 6 1/2  
 Light Distribution: Adjustable / Direct  
 Fixture Finish: BAL / MWL / BSL  
 Fixture Material: Extruded Aluminum

#### ELECTRICAL

Number of Lamps: 1  
 Lamp Type: LED  
 Total Output Wattage (W): 9.3  
 Dimming: Phase Dimming (120Vac Only)  
 Input Voltage (V): 120

#### LED

Number of LEDs: 1  
 Color Temperature (°K): 3000  
 Max. Delivered Lumen (lm): 956  
 CRI: >90 CRI  
 Lamp Life (hrs): 50000

#### OPTICAL

#### RATINGS AND CERTIFICATIONS

Certified By: Certified for North American Standards  
 IP rating: IP20

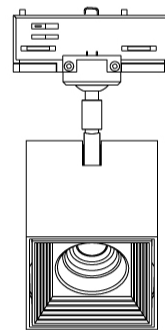
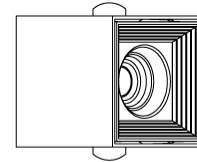

80mm 3 1/8"

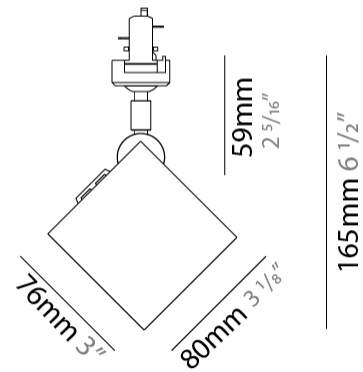

## DAU SINGLE TRACK

D96048R9-

PROJECT \_\_\_\_\_

TYPE \_\_\_\_\_

SPECIFIER \_\_\_\_\_

QUANTITY \_\_\_\_\_

DATE \_\_\_\_\_

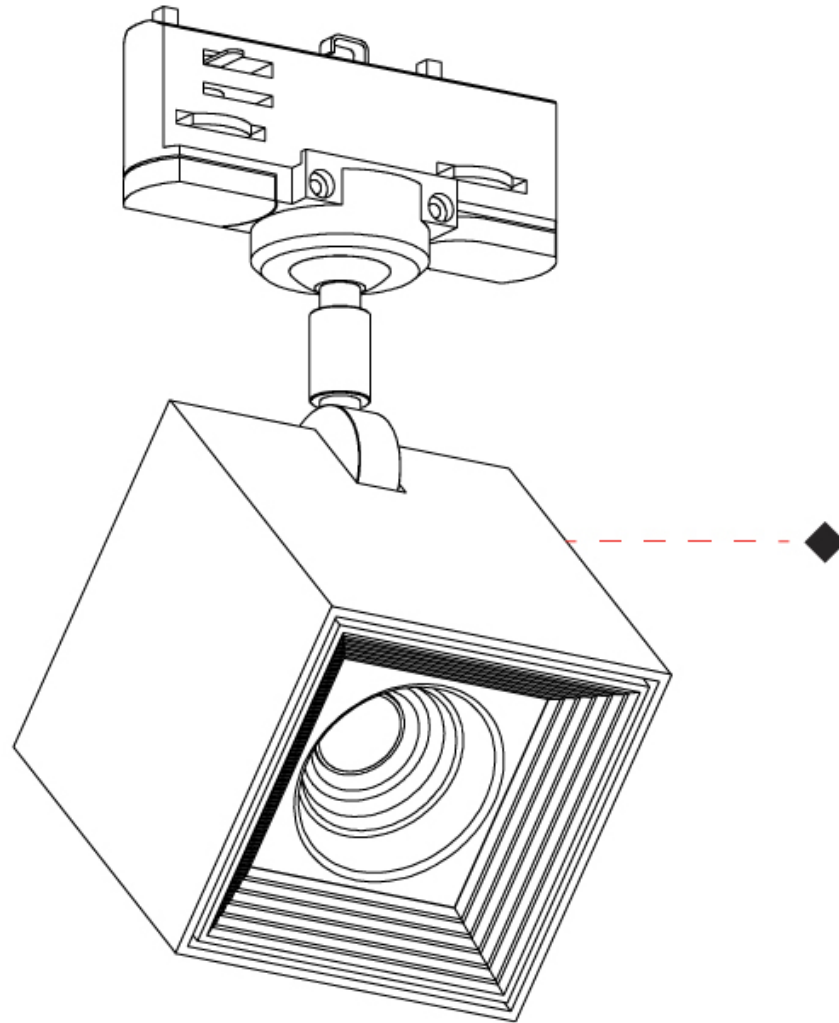

D

PROJECT

TYPE

SPECIFIER

QUANTITY

DATE

#### Fixture Finish

Brushed Aluminum - BAL



Matte White Lacquer - MWL



Black Satin Aluminum - BSL

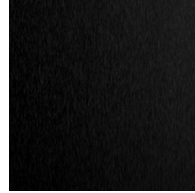

Chrome - CHR



Matte Black Lacquer - MBL

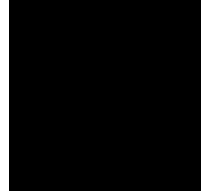

**Digital:** Not all screens are calibrated the same, and therefore, colors will appear differently between screens.











**Physical:** When texture is involved, there will be variations in color, character and tone within a product series and between product families.



### LEGEND

 floor-mounted	 pivotable	 special LED (upon request) RGB, RGBW, tunable, gold+, meat+, art+, fashion+
 wall and ceiling: recessed and surface mounted	 rotating	 warm dim / natural dimming LED
 ceiling-mounted and wall-mounted	 illuminate tilted	 rechargeable battery powered
 wall-mounted	 color of suspension cable	 fixture with natural vivid LED (upon request)
 omni-directional light distribution	 length of suspension cable	 color rendering index
 direct light distribution	 reflector degree selection	 color temperature
 direct/indirect light distribution	 super spot	 lumen (luminous flux)
 indirect light distribution	 lens	 efficacy (lumens per watt)
 asymmetric light distribution	 lens pack	 Unified Glare Rating (UGR) range from 5-40
 aura light distribution	 shine ring	 marine grade (AISI 316 stainless steel)
 round wall or ceiling cut-out	 integrated shine ring with diffuser	 walk on
 square wall or ceiling cut-out	 free individual colors 01-29	 drive on
 the supplied jig specifies the cutout dimensions	 individual colors: 00 (free of charge), 01-25 (extra charge)	 Dark Sky Compliance
 minimum distance (meters) lamp - object	 luminaire part to be colored (F1)	 Americans with Disabilities Act (less than 4" off the wall located between 27"-84" from floor)
 recessed depth	 luminaire part to be colored (F2)	 lamp protected against explosion
 ceiling thickness in mm	 luminaire part to be colored (F3)	 blown glass using traditional methods by master glass blower
 ceiling thickness selection	 luminaire part to be colored (F4)	 acoustic material
 dimmable DP (phase), DV (0-10V), DD (dali), DS (step-dim)	 luminaire part to be colored (F5)	 protection class I, protection insulation
 included or excluded LED driver/transformer/control gear	 color of 3-circuit adaptor	 protection class II, protection insulation
 separately switchable	 indirect diffuser	 ETL Certified to UL and CSA Standards
 sensor	 direct diffuser	 UL Certified to UL and CSA Standards
 remote control	 ball-proof (upon request)	 CSA Certified to UL and CSA Standards
 available upon request	 accessory	 Certified for North American Standards

### IP RATING

 IP20	protected against ingress of solid bodies greater than 12.5mm (finger)
 IP33	protected against ingress of solid bodies greater than 2.5mm protected against sprays of water up to 60 degrees from the vertical (rain)
 IP40	protected against ingress of solid bodies greater than 1mm (wire) no protection against the ingress of moisture
 IP43	protected against ingress of solid bodies greater than 1mm (wire) protected against sprays of water up to 60 degrees from the vertical (rain)
 IP44	protected against ingress of solid bodies greater than 1mm (wire) protected against water splashed from all directions
 IP54	protected against limited ingress of dust (wet rooms/covered outdoor areas) protected against water splashed from all directions
 IP65	protected against ingress of dust protected against jets of water
 IP66	protected against ingress of dust protected against powerful jets of water or heavy seas
 IP67	protected against ingress of dust protected against immersion of water between 15cm - 1m for 30 minutes
 IP68	protected against ingress of dust protected against immersion of water under pressure for long periods

### IK RATING

 IK01	protected against 0.14 joules impact (equivalent to 0.25kg mass dropped from 56mm above the surface)
 IK02	protected against 0.2 joules impact (equivalent to 0.25kg mass dropped from 80mm above the surface)
 IK03	protected against 0.35 joules impact (equivalent to 0.25kg mass dropped from 140mm above the surface)
 IK04	protected against 0.5 joules impact (equivalent to 0.25kg mass dropped from 200mm above the surface)
 IK05	protected against 0.7 joules impact (equivalent to 0.25kg mass dropped from 280mm above the surface)
 IK06	protected against 1 joules impact (equivalent to 0.25kg mass dropped from 400mm above the surface)
 IK07	protected against 2 joules impact (equivalent to 0.5kg mass dropped from 400mm above the surface)
 IK08	protected against 5 joules impact (equivalent to 1.7kg mass dropped from 300mm above the surface)
 IK09	protected against 10 joules impact (equivalent to 5.0kg mass dropped from 200mm above the surface)
 IK10	protected against 20 joules impact (equivalent to 5.0kg mass dropped from 400mm above the surface)